

MARTEL 300

WLML300RC

SCONCE

Design by Felix Millory

220V
SPECSHEET
13/02/2026



ENTRELACS

HAND-MADE IN FRANCE

MARTEL 300

WLML300RC

SCONCE

Design by Felix Millory



Hand-Made in France with passion
in our Family Foundry established in 1982



ENTRELACS

MARTEL 300

WLML300RC

SCONCE

Design by Felix Millory

220V

DEFINITION OF SYMBOLS

13/02/2026



ELETRICAL DANGER



COMPONENT INSIDE



REMOTE COMPONENT



DIGITAL ADDRESSABLE LIGHTING INTERFACE



NUMBER OF PEOPLE REQUIERED



DISPOSAL OTHER THAN URBAN WASTE



COLOR RENDERING INDEX



COLOR



INGRESS PROTECTION CODE



LED PRESENCE



INTERIOR FIXTURE



0.10 V DIMMING



EUROPE NORM



CLASS 2 EU



GROUND / CLASS 1 EU



ENTRELACS

Warranty and care instructions

You have just acquired an Entrelacs lighting fixture and we thank you.

All of our achievements are based on an exceptional know-how for more than 40 years. Made from cast bronze and alabaster, your fixture is designed to last a lifetime. The integrated electrical components were chosen for their manufacturing quality and their remarkable colors rendering.

Dismantling the luminaire is strictly prohibited to avoid the risk of electrocution and loss of warranty. The light source contained in this luminaire must

be replaced by us, or a similarly qualified person. For installation, please follow the installation instructions. If your luminaire has a flexible external cable or cord and it becomes damaged, it must be replaced by us or a person with similar qualifications. Alabaster is a fragile material and in the event of a crack or even breakage you must contact us to have it replaced.

All our lighting fixtures are guaranteed for 2 years.

Bronze does not require any special maintenance. However, in order to guarantee the protection of the patina, your lighting fixture is protected by a protective varnish. We invite you to follow some tips.

- cut off the power supply before any maintenance or cleaning operation
- do not use hydroalcoholic products such as glass surface cleaning products or others
- we do not recommend using liquid to clean it
- avoid direct exposure to the rays of the sun and the moon
- remove dust using a soft cloth



General safety instructions

Read the instruction manual thoroughly before using the appliance.

WARNING: When using electrical appliance, basic safety precautions should always be followed to reduce the risk of fire, electrical shock and personal injury. The power supply must be deactivated prior to assembly, maintenance, exchanging the light source or cleaning process.

ELECTRICAL SAFETY: the lighting should be installed by authorized electrician only.

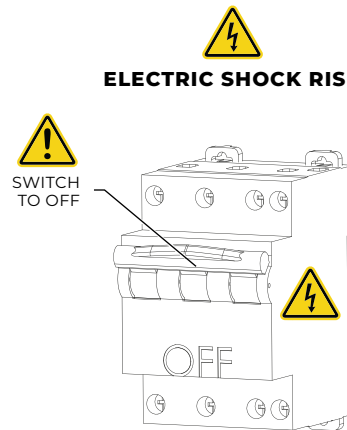

Screws provided are not applicable to all surfaces and ceilings.

In the case of a specific way of fixing the product please use suitable screws at your disposal.

Compliance

This product complies with the requirements of Annex 1 DBT (decree 2015 - 1083 of August 27, 2015 relating to the making available on the market of electrical equipment intended to be used within certain voltage limits)

Electrical products must not be thrown out with domestic waste.

They must be taken to a communal collecting point for environmentally friendly disposal in accordance with the local regulations. Contact your local authorities or stockist for advice on recycling.

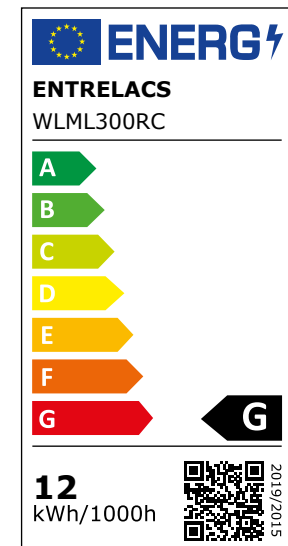

MARTEL 300

WLML300RC

SCONCE

Design by Felix Millory

220V
SPECSHEET
13/02/2026



Déclaration de conformité CE

(Conformément à la Directive 2014/35/UE sur la basse tension et la Directive 2011/65/UE RoHS)

Le produit mentionné ci-dessous est conforme aux exigences essentielles des directives européennes suivantes :

1. Fabricant :

Nom de l'entreprise : FONDERIE MACHERET
Adresse : 31 Z.A LA PECARDIERE, 72450 MONTFORT LE GESNOIS
Téléphone : 02 43 54 84 84
E-mail : yves@fonderie-macheret.fr

2. Produit :

Dénomination : Applique lumineuse MARTEL
Modèle : WLML300RC
Marque : ENTRELACS
Date de fabrication : _____

3. Description du produit :

Type : Murale
Puissance : 12W
Classe de protection : Classe I
Indice de protection (IP) : /

4. Directives et normes appliquées :

Directive 2014/35/UE (Directive Basse Tension – LVD)
Directive 2014/30/UE (Compatibilité Électromagnétique – CEM)
Directive 2011/65/UE (Restriction des substances dangereuses – RoHS)
Normes harmonisées appliquées :

NF EN 60598-1:2021 – Luminaires – Exigences générales et essais
NF EN 60598-2-1:2021 – Luminaires – Exigences particulières
EN 55015:2019 – Compatibilité électromagnétique
EN 61000-3-2:2019 / EN 61000-3-3:2013 – Limitation des émissions de courant harmonique

Montfort le Gesnois Le
01/01/2024

Macheret Yves
Co-Gérant



ENTRELACS

MARTEL 300

WLML300RC

SCONCE

Design by Felix Millory

MATERIALS **SOLID BRONZE & ALABASTER**

LED SOURCES **LED COB**

POWER SUPPLY **120-277 V / 50-60Hz**

LUMENS **535 Lumens**

WATTS **12W**

WEIGHT KG [lbs] **2.5 [5.5]**

STANDARD

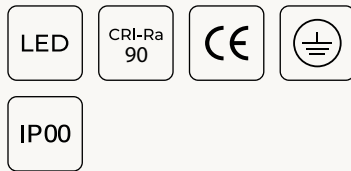

LED COLORS
NO UPCHARGE

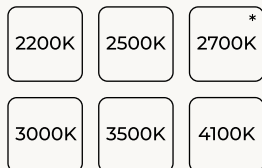

DIMMING CONTROL

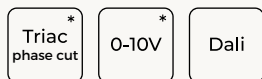

DRIVER POSITION



*Standard setting

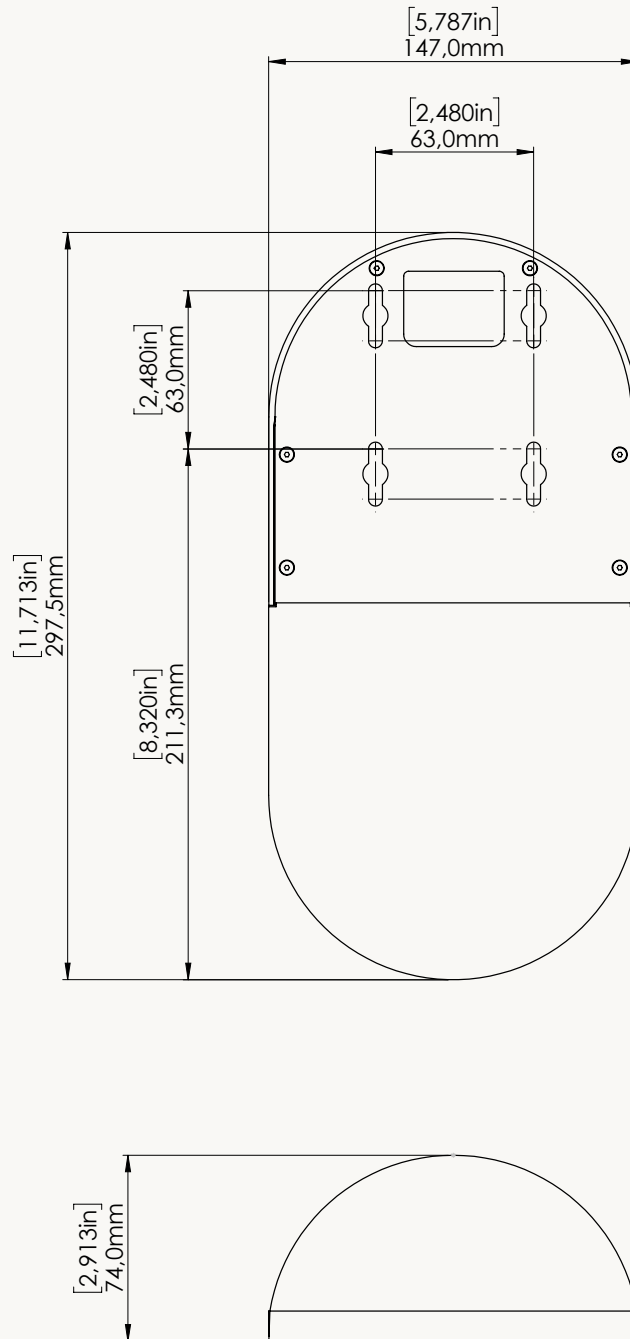

220V
SPECSHEET
13/02/2026

finishes

BRONZE PATINAS

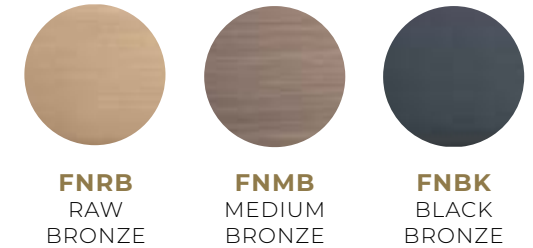

SPECIAL UPCHARGE



ALABASTER TYPE

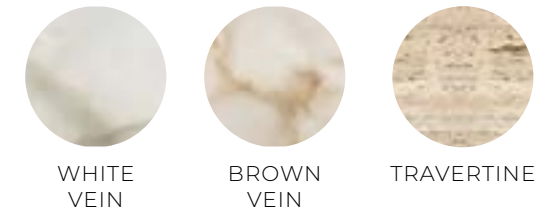

ENTRELACS

DS12W700C1018MB1UD

MANUFACTURER	LTF TECHNOLOGY
MODEL NUMBER	DS12W700C1018MB1UD
AC INPUT	120-277 VAC - 0.12A - 50/60Hz
DC OUTPUT	10-18V (CONSTANT CURRENT)
WATTS	12W
EFFICIENCY	>85%
POWER FACTOR	>0.95
CASE TC	90°C MAX
PROTECTION	INPUT / OUTPUT
STORAGE	-30°C / +90°C
HUMIDITY	95% RH MAX
IP RATING	IP 67
PROTECTION CLASS	Class 2 Power Supply
DIMMING	ELV, TRIAC, 0-10V

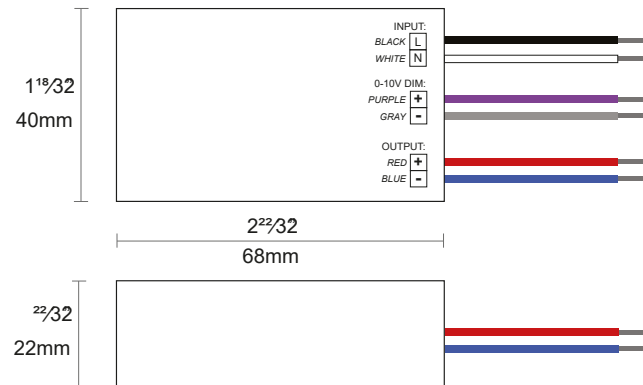

LCM-25-DA

MANUFACTURER	MEAN WELL
MODEL NUMBER	LCM-25-DA
AC INPUT	200-240 VAC - 0.2A - 50/60Hz
DC OUTPUT	1.05A - 0.35A(CONSTANT CURRENT) 24 V - 54 V
WATTS	25W
EFFICIENCY	86%
POWER FACTOR	>0.91
CASE TC	85°C MAX
PROTECTION	INPUT / OUTPUT
STORAGE	-40°C / +80°C
HUMIDITY	20-90% RH MAX
IP RATING	/
PROTECTION CLASS	Class 2 Power Supply
DIMMING	Dali

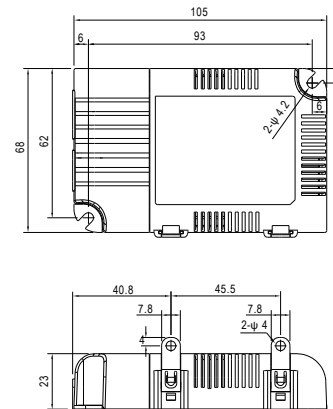

MARTEL 300

WLML300RC

SCNCE

Design by Felix Millory

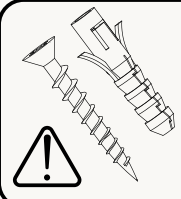

 **In the case of inappropriate ceiling/wall type screws shown on this notice are for reference only. USE YOUR OWN**

CONTENT

13/02/2026

THE VISUALS SHOULD BE USED FOR THE FOLLOWING REFERENCES :

WLML300RC

ANY HELP ?

support@entrelacs-creation.fr

WHATSAPP

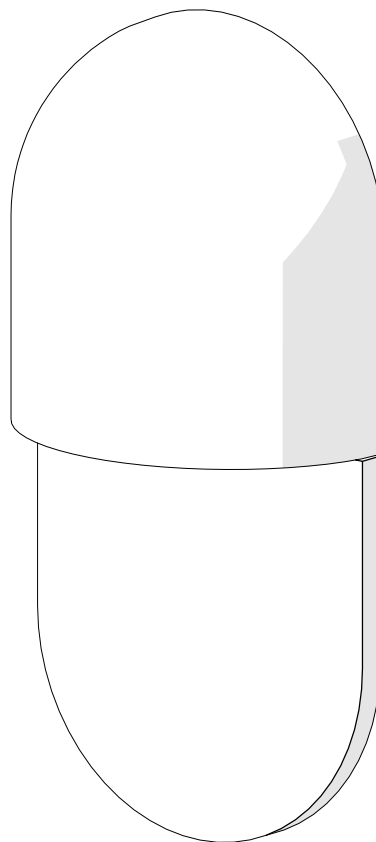

1x LAMP KIT

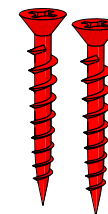

2x WOOD SCREW Ø4x30

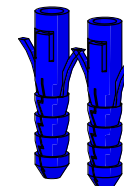

2x FIXING PIN Ø6x30

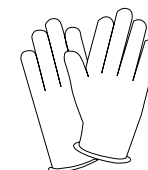

1x PAIR OF GLOVES



ENTRELACS

MARTEL 300

WLML300RC

SCONCE

Design by Felix Millory



 In the case of inappropriate ceiling/wall type screws shown on this notice are for reference only. USE YOUR OWN

THE VISUALS SHOULD BE USED FOR THE FOLLOWING REFERENCES :

WLML300RC

ANY HELP ?

support@entrelacs-creation.fr

WHATSAPP



ASSEMBLY VIEW

13/02/2026

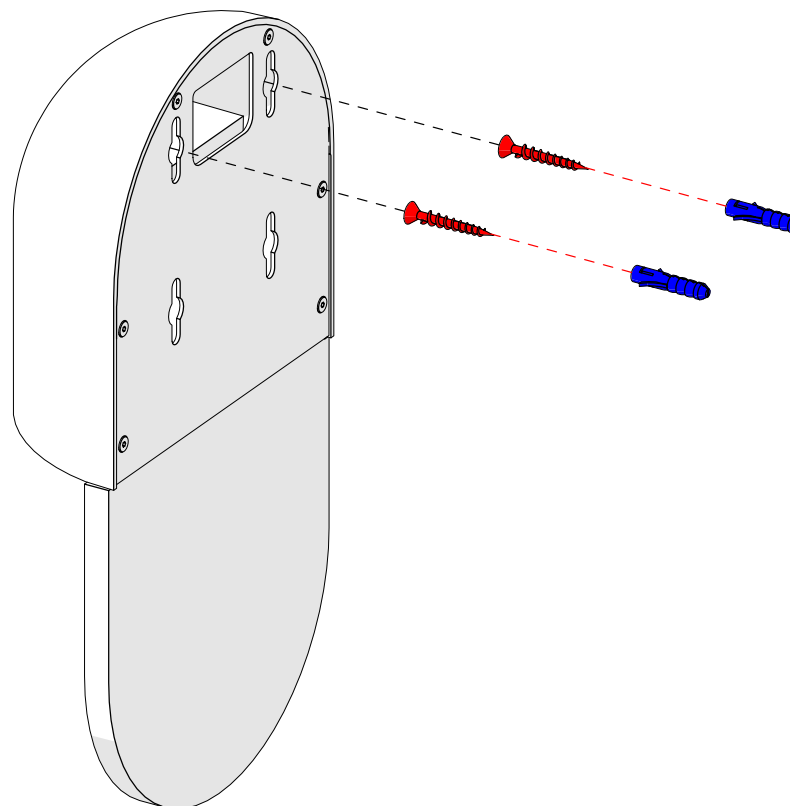

ENTRELACS

MARTEL 300

WLML300RC

SCONCE

Design by Felix Millory



 In the case of inappropriate ceiling/wall type screws shown on this notice are for reference only. USE YOUR OWN

THE VISUALS SHOULD BE USED FOR THE FOLLOWING REFERENCES :

WLML300RC

ANY HELP ?

support@entrelacs-creation.fr

WHATSAPP



INSTALLATION INSTRUCTIONS

13/02/2026

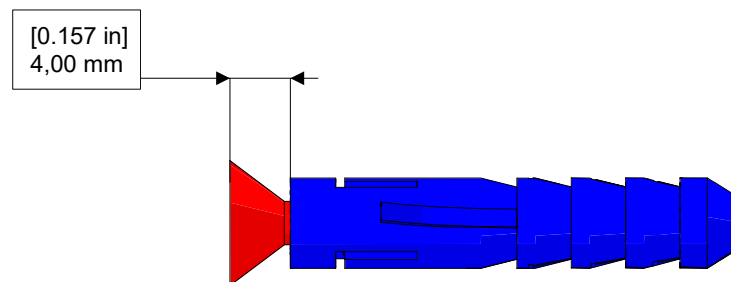
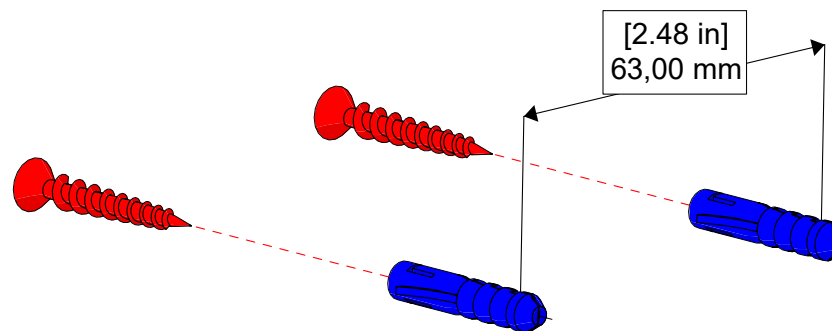

ENTRELACS

MARTEL 300

WLML300RC

SCONCE

Design by Felix Millory



 In the case of inappropriate ceiling/wall type screws shown on this notice are for reference only. USE YOUR OWN

THE VISUALS SHOULD BE USED FOR THE FOLLOWING REFERENCES :

WLML300RC

ANY HELP ?

support@entrelacs-creation.fr

WHATSAPP



INSTALLATION INSTRUCTIONS

13/02/2026

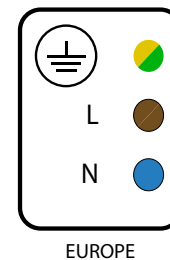
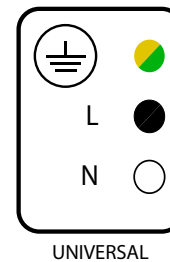
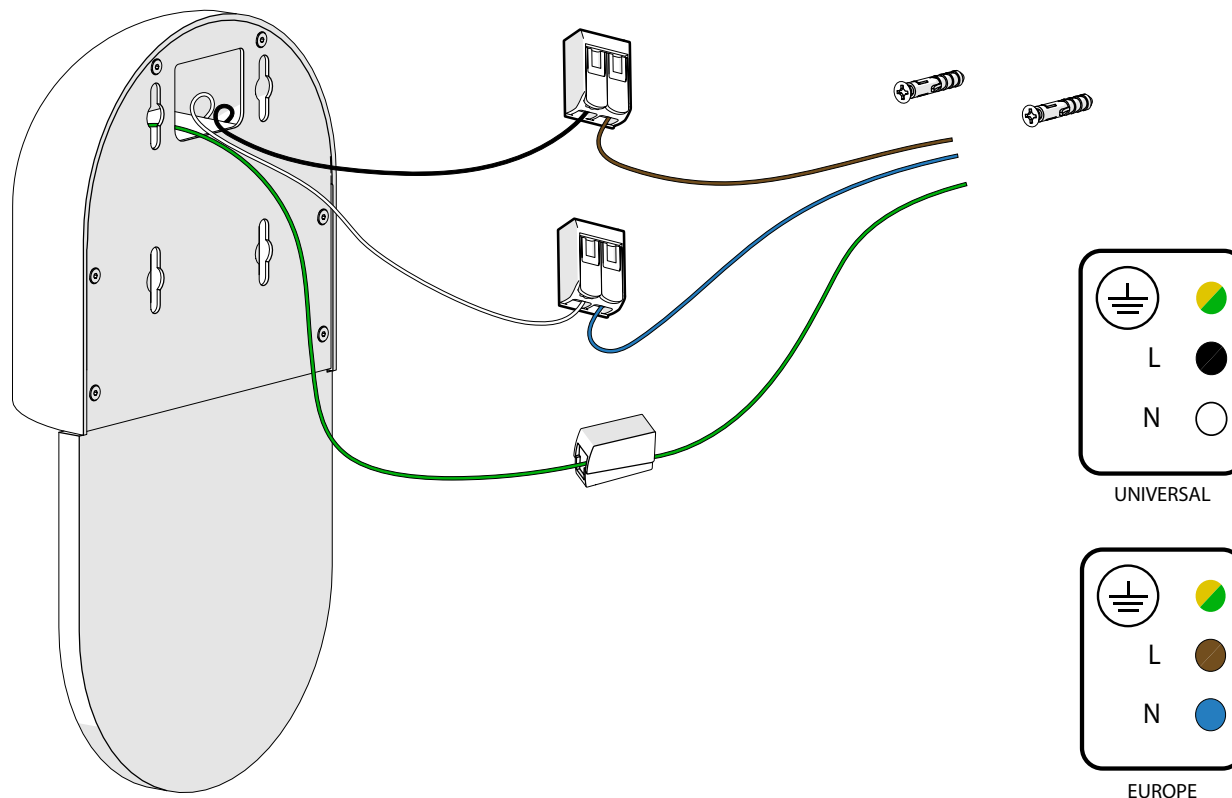

ENTRELACS

MARTEL 300

WLML300RC

SCONCE

Design by Felix Millory



 In the case of inappropriate ceiling/wall type screws shown on this notice are for reference only. USE YOUR OWN

THE VISUALS SHOULD BE USED FOR THE FOLLOWING REFERENCES :

WLML300RC

ANY HELP ?

support@entrelacs-creation.fr

WHATSAPP



INSTALLATION INSTRUCTIONS

13/02/2026

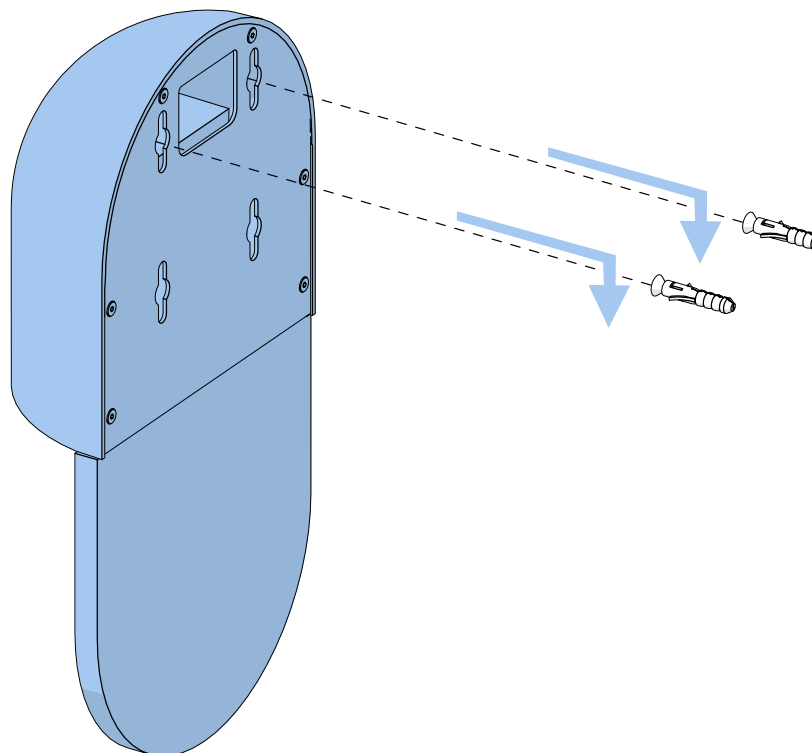



ENTRELACS

MARTEL 300

WLML300RC

SCONCE

Design by Felix Millory



In the case of inappropriate ceiling/wall type screws shown on this notice are for reference only. USE YOUR OWN

THE VISUALS SHOULD BE USED FOR THE FOLLOWING REFERENCES :

WLML300RC

ANY HELP ?

support@entrelacs-creation.fr

WHATSAPP



INSTALLATION INSTRUCTIONS

13/02/2026

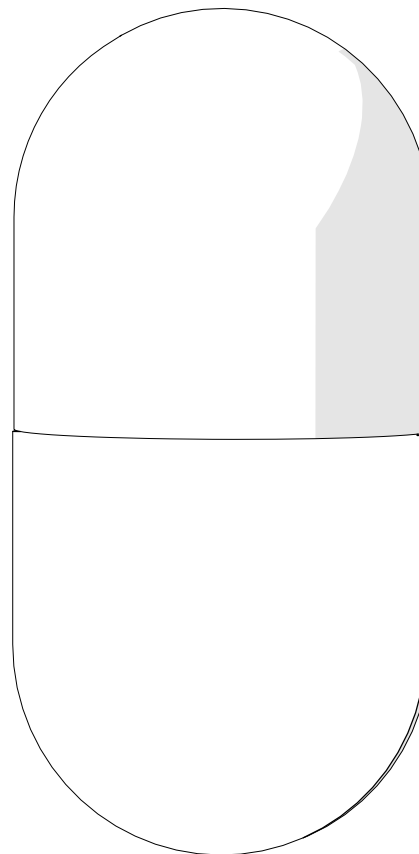

ENTRELACS



ENTRELACS
HAND - MADE IN FRANCE

ENTRELACS is a registered trademark
of FONDERIE D'ART MACHERET
31 ZA la Pécardière - 72450 Montfort le Gesnois - FRANCE
tel. +33 (0)2 43 54 84 84 - contact@entrelacs-creation.fr